

LYNGDORF AUDIO MP-40

# OWNER'S MANUAL

## TABLE OF CONTENTS

Compliance .....	5
WEEE.....	5
FCC.....	5
Introduction.....	6
Pre-installation.....	7
Unpacking the product .....	7
Inventory .....	7
Operating voltage.....	7
Ventilation requirements .....	7
Home automation system integration.....	8
IP control .....	8
Preparing the MP-40 for mounting in a rack.....	8
Rear Panel .....	9
Remote control .....	10
How to pair remote control in RF mode .....	11
Switching remote between RF and IR mode.....	11
Setup procedure.....	11
Installation via installer menu .....	11
Installation via web interface .....	12
HOME screen.....	12
SETUP .....	13
Source .....	13
Add/edit Source.....	13
Source name .....	13
Lipsync offset (ms) .....	13
Volume offset (dB) .....	13
Audio input .....	13
Default postprocessing .....	13
Default voicing .....	13
Video input .....	13
Trigger out .....	14
Preset vTuner station .....	14
Arrange .....	14
Delete.....	14
Speakers and room .....	14

RoomPerfect™ .....	17
Global filter .....	17
Focus position .....	17
Initial setup .....	17
How to measure distances to speakers and subwoofers .....	17
Adjust subwoofer.....	18
How to set up RoomPerfect™ .....	18
RoomPerfect™ preparations.....	18
Placing the microphone in the focus position.....	19
Volume setting .....	19
Measuring the focus position .....	19
Measuring random room positions.....	20
Room measurements above 90% RoomKnowledge .....	21
Calculation of focus and global filters.....	22
Audio Setup.....	23
Audio Processing .....	23
Voicing Setup .....	23
Exporting and Importing Voicings .....	23
Edit or delete voicing.....	24
Add new voicing.....	24
Replace all voicings from file.....	24
Creating voicings.....	24
Zone B setup .....	25
System configuration .....	26
General setup.....	26
Power management .....	26
Default volume settings .....	26
HDMI CEC settings .....	26
Display timeout .....	26
Password protection .....	26
Show bypass .....	26
Enable front IR sensor .....	26
OSD info level .....	27
Trigger In setup .....	27
Trigger Out setup .....	27
Network configuration .....	27

Streaming setup.....	27
Streaming playback.....	27
UPnP.....	28
USB.....	28
vTuner.....	28
AirPlay.....	28
Spotify Connect.....	28
Manage Software.....	28
Software Information.....	28
Network Information.....	29
Backup.....	29
Restore.....	29
Factory Reset.....	29
Software Update.....	29
Update from remote files.....	29
Update from local files.....	29
Via web interface:.....	29
Update Via OSD Interface.....	30
Troubleshooting.....	30
RoomPerfect™.....	30
Error Messages.....	30
No microphone connected.....	30
Fault – No signal.....	30
Fault – Signal clipping.....	31
Fault – Low signal.....	31
Can't Turn On Via LAN or Control System.....	31
Retrieving and Sending an Error Log.....	31
3D Compatibility Not Detected.....	31
Remote Control Doesn't Work.....	32
Network Setup.....	32
Connecting to MP-40 with a network cable.....	32
Set Up a Fixed IP Address in Windows 7.....	33
Set Up a Fixed IP Address in Windows Vista or Windows 10.....	33
Trademarks.....	34
Service information.....	34

## Compliance

### WEEE

The European Parliament and the Council of the European Union have issued the Waste Electrical and Electronic Equipment Directive. The purpose of the Directive is to prevent waste of electrical and electronic equipment and to promote reuse, recycling, and other forms of waste recovery. Lyngdorf products and the accessories packed with them are subject to the WEEE Directive. Please dispose of any waste materials in accordance with your local recycling regulations. Products and equipment which must be collected for reuse, recycling, and other forms of recovery are marked with the icon of the crossed-out waste receptacle.



### FCC

Lyngdorf products and accessories comply with parts 15 and 68 of the FCC rules. Operation is subject to the following two conditions: (1) this device may not cause harmful interference; and (2) this device must accept any interference received, including any interference that may cause undesired operation.

Changes or modifications not expressly approved by the party responsible for compliance could void the user's authority to operate the equipment. Equipment marketed to a consumer must be capable of complying with the necessary regulations in the configuration in which the equipment is marketed.

## Introduction

The MP-40 is an advanced processor with full support of the latest Dolby® Atmos, DTS:X and Auro-3D® surround sound formats. The processor can decode 10 discrete channels from the source and features 16 balanced XLR outputs for the discrete channels, additional subwoofer outputs as well as channels designed as matrixed/mixed from the discrete channels. Whatever your setup is, the MP-40 will provide the optimal performance due to its bass-management and room correction system, RoomPerfect™.

Both Dolby, DTS and Auro provides modes for processing legacy formats or for upmixing the sound into all your speakers. This is referred to as POST PROCESSING, and it can be set on a Source or controlled from your remote control.

The MP-40 will support any setup from the simplest stereo setup to the most advanced 3D surround setup, and we have made great efforts for having a simple user interface, where all settings are displayed and arranged for easy installation.

Please read through this manual for understanding the functions available – or as later reference. The latest version of this manual is available for download from [www.lyngdorf.com](http://www.lyngdorf.com)

Enjoy!

## Pre-installation

Please read all material carefully prior to installation. If you need additional assistance, contact your Lyngdorf Audio representative or visit [www.lyngdorf.com](http://www.lyngdorf.com).

## Unpacking the product

Carefully remove the unit and accessory kit from the carton and check for shipping damage. Contact the shipper and your Lyngdorf Audio representative immediately, if the unit bears any sign of damage.

---

*Note: Keep the shipping carton and all packing material for future use. If this unit is shipped for service without the original packing, damage could occur and void the warranty.*

---

## Inventory

Check the list below to ensure that all necessary product components have been delivered. Report all discrepancies to your Lyngdorf Audio representative immediately.

- Owner's manual
- Power cord
- Remote
- Microphone
- Microphone stand
- Microphone cable
- Rack ears

## Operating voltage

Lyngdorf Audio products must be connected to the mains power system only. The MP-40 will automatically detect voltage between 100-240v.

## Ventilation requirements

The MP-40 does not have a built-in fan, nor does it require special measures to ensure proper heat dissipation. It should be placed according to these guidelines:

- It should always have at least one inch / 25mm of free space on all sides.
- It should be placed in an environment free of excessive heat.
- In a rack system, the MP-40 should be placed at the bottom of the rack, still with at least one inch / 25mm free space on all sides.

## Home automation system integration

The MP-40 is compatible with home automation systems via the RS232 and network connector on the rear socket panel. The MP-40's IR and trigger connections can also be programmed for use in a home automation system.

## IP control

Access the MP-40 by going to <http://mp40.local> in your browser.

Pressing the OK button on the remote and toggling through the information, you will see the IP address allocated to the MP-40.

Open a TCP connection on port 84 and use the same protocol as on the serial interface. Use Telnet, Putty, or a similar program to open the TCP connection.

If you do not know the IP address of the MP-40 on your local network, the MP-40 supports Apple's Bonjour Discovery service, which must be on the computer with which you wish to set up the MP-40. The software is built-in as part of the Apple OS X operating system (not iOS devices). For Windows operating systems, the software can be found at <http://www.apple.com/support/bonjour/>

## Preparing the MP-40 for mounting in a rack

The MP-40 processor is equipped from the factory with feet for free-standing placement.

To install the MP-40 in a rack:

1. Turn the MP-40 upside-down and place it on a stable, even surface.
2. The screws used to fasten the rack brackets to the bottom of the MP-40 are in the holes designated for the brackets when the product leaves the factory.
3. Fasten the brackets for rack mounting to the MP-40.
4. If so required, the feet can be removed
5. Mount the MP-40 in a rack.



## Rear Panel



On the back of the MP-40, you will find a range of inputs and outputs:

- 16 x Differential balanced audio outputs (configured for 11.1 plus 4 auxiliary)
- 3 x HDMI inputs and 1 x HDMI outputs, all 4K / HDR compatible (HDMI 2.0b / 18 Gbps)
- 1 x HDBaseT™ output
- 2 x USB A connectors, for music file playback, backup, software updating, etc.
- 1 x Streaming USB B audio input
- 1 x RJ45 Network connector (LAN)
- 1 x Microphone input for the RoomPerfect™ room correction microphone
- 1 x SD card slot for storing backup data
- 3 x IR inputs
- 1 x Trigger input and 4 x trigger outputs
- 1 x RS-232 connector for serial control of the unit
- 4 x Optical, 1 x AES/EBU and 3 coaxial digital audio inputs
- 1 x Coaxial digital audio output (for Zone B)

---

*Note: The processor can decode maximum 12 speaker channels plus create additional four auxiliary channels, like subwoofer outputs or Top Middles as a mix of Top Fronts and Top Rears.*

*Note: Differential balanced output connection means that PIN 1 is Shield/Ground, PIN2 holds audio signal and PIN 3 holds an inverted audio signal. If your power amplifier requires a single ended (RCA) connection, you must ensure that the PIN 3 is disconnected (lifted). PIN 3 in the MP-40 connector may not be connected to ground.*

---

## Remote control

The MP-40 comes with a dedicated remote control, which can operate both with radio frequencies (RF) and infrared control (IR).

<b>Setup</b>	Access the installation menu.
<b>Standby</b>	Turn the MP-40 on and into standby.
<b>Audio</b>	Access the post-processing menu.
<b>Trim</b>	Access to miscellaneous audio adjustments.
<b>Up/Down</b>	Move up and down in menus. Browse available settings in a menu. Toggles between the available RoomPerfect™ filters.
<b>Left/Right</b>	Move left and right in menus. Toggle between neutral and the available voicings.
<b>OK</b>	Activate the info screen, indicating the status of the unit. Select a menu and store a selected setting.
<b>Back</b>	Return to the previous menu.
<b>Menu</b>	Access the user menu.
<b>SRC</b>	Access the source menu list.
<b>Source +/-</b>	Toggle between active sources.
<b>Volume +/-</b>	Turn volume up and down.
<b>Mute</b>	Mute and restore the sound.
<b>Play/Pause</b>	Play/pause the currently playing track in the media player.
<b>Skip Forward / Skip Backwards</b>	Skip in the current playlist in the media player.



## How to pair remote control in RF mode

The MP-40 remote has both an IR and RF mode, and is by default set to IR.

To pair the RF remote control to the MP-40:

1. Turn on the MP-40.
2. Hold down Play/Pause and OK until the remote control's green LED flashes.
3. Release the buttons.
4. Point the remote control at the MP-40 and hold it within 30 cm / 1 foot of the front panel; when the green LED stops blinking, the remote is connected.
5. The remote is now RF paired to the MP-40.

To reset the pairing of the remote control, press Back and OK until the red LED flashes twice.

## Switching remote between RF and IR mode

To switch the remote from IR to RF mode, hold down OK and 2. The LED will flash green twice.

To switch the remote from RF to IR mode, hold down OK and 1. The LED will flash red twice.

If you press a button on the remote and the red LED at the top turns on, then you are in IR mode. If it turns green you are in RF mode.

## Setup procedure

Set up the MP-40 surround sound processor by following these steps:

1. Connect the speakers to the power amplifier(s).
2. Connect all external equipment (audio & video, home automation system, mains, etc.) to the MP-40.
3. Switch on the MP-40 and all connected equipment.
4. Access the setup menu via the web interface or the Installer Menu on the screen.
5. Go to "Speaker and Room" and set up the system.
6. Connect the amplifiers to the specified outputs.
7. Select and press "Verify speakers."
8. Adjust level(s) on your subwoofer(s) by the feature "Adjust Sub".
9. Run RoomPerfect™ Guided Setup.
10. Set up video sources, audio, Zone B etc.
11. Save and back up settings.

## Installation via installer menu

Connect a screen to the MP-40 using any of the video output sockets on the back. Access the menu system by pressing the Setup button on the remote control.

---

*There are some differences between how the web interface and the Installer Menu. This manual describes how to set up via the installer Menu interface.*

---

### **Installation via web interface**

You will need a computer, and the MP-40 must be connected to an existing network, or you may use a crossover network cable for direct connection.

If you do not know the IP address of the MP-40 on your local network, the MP-40 supports Apple's Bonjour Discovery service, which must be on the computer with which you wish to set up the MP-40. The software is built-in as part of the Apple OS X operating system (not iOS devices). For Windows operating systems, the software can be found at <http://www.apple.com/support/bonjour/>

- Access the web menu by typing **http://mp40.local/** in your browser. Or
- Press the OK button on the remote. Toggling through will display the IP address.

### **HOME screen**

The HOME screen refers to the daily operation as performed with the remote control. The page displays selected input and formats.

Loudness management turns on a traditional loudness function for low playback levels as well as functions dedicated to the specific formats being decoded. These functions are managed in the setup menu: Audio Setup / Audio Processing.

The interface for controlling the built-in media streamer is found in the bottom section of this page. For information as to the use of the interface see the "Streaming Setup" section.

## SETUP

The SETUP screen refers to all basic settings and option in the installation of the processor.

### Source

In the Source menu, you will find a list related to the input connectors. This register is though very flexible as a Source can be specified to use individual inputs for audio and video. This means that several sources can relate to the same input connectors and vary in relation to the content, such as “Action Movie” and “Music Video” being identical in connections, but different in Post Processing, Voicings and trigger actions.

#### Add/edit Source

##### *Source name*

Input the name for the source.

##### *Lipsync offset (ms)*

Set delay time in milliseconds to ensure that the video and audio signals are played back simultaneously.

##### *Volume offset (dB)*

Enables you to match input levels from different sources.

##### *Audio input*

Select the audio input connector. If you want the audio input to match the video input from an HDMI source, select HDMI Audio.

##### *Default postprocessing*

Select the default postprocessing mode.

##### *Default voicing*

Select the default voicing.

##### *Video input*

Select the video input connector.

### *Trigger out*

Choose which trigger output to activate when using this source. (The interface for controlling the triggers is found in the Trigger Setup under System Configuration)

### *Preset vTuner station*

Selects stored presets of the vTuner Internet radio station. (The interface for controlling the built-in media streamer with vTuner is found in the bottom section of the HOME page.)

---

*To save changes, you must press “Accept” after making changes to a single input. Do not go to the next input before saving changes.*

---

## **Arrange**

Change the order of a source by:

- Highlighting it
- Moving it out of the stack by pressing right on the remote
- Moving the source by pressing up/down
- Reinserting it by pressing left.

## **Delete**

Delete an enabled source by highlighting it and pressing right on the remote.

## **Speakers and room**

The purpose of the speaker setup is to tell the system which speakers and subwoofers are available and how big they are, which in turn reveals how much bass they are capable of reproducing.

References to “speakers” in this document are specific to satellite or full-range speakers and do not include subwoofers. The setup page is an overview of the possible speaker outputs, which you can activate.

As factory default the MP-40 is displaying a 7.1 speaker configuration as shown here:

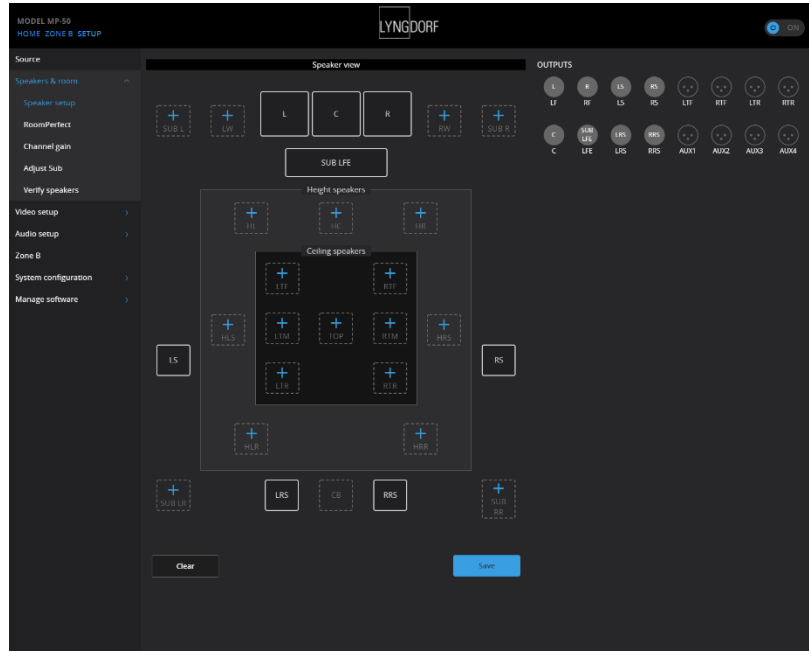

Channel Designations	Channel Description
----------------------	---------------------

Low level speakers:

L	Left
R	Right
C	Center
LS	Left surround
RS	Right surround
LRS	Left rear surround
RRS	Right rear surround
CB	Center back

Speakers designated according to Dolby ATMOS and DTS:X specifications:

LW	Left wide
RW	Right wide
LTF	Left top front
RTF	Right top front
LTM	Left top middle
RTM	Right top middle
LTR	Left top rear
RTR	Right top rear

Speakers designated according to AURO 3D specifications:

HL	Height left
HR	Height right
HLS	Height left surround
HRS	Height right surround
HC	Height center
TOP	Top ceiling / Voice of God

You need to configure the MP-40 according to your speaker setup, setting the sizes of the speakers so that the Bass Management function can optimize the performance. In the setup page the connectors will be highlighted with information as to signal type.

In a separate document, called **Speakers and Bass Management**, you will find detailed descriptions as to the options available, but we want to emphasize a few basic issues:

A single subwoofer must be set as LFE subwoofer – no matter where you position it in the room

Sub Right and Sub Left is used in combination only, as it is used for a stereo setup – but you can activate both the LFE subwoofer and the Sub Right/Sub Left.

The MP-40 can decode up to 12 channels (including the LFE, Low Frequencies Effects) and output these 12 native channels plus up to 4 derived channels, such as:

- LW and RW (Wide front speakers – being a mix of front and surround speakers).
- RTM and LTM (Top Middle speakers – being a mix of front and rear top speakers)
- Sub Right and Sub Left – Stereo Subwoofer channels handling low frequencies only.

The system will inform you if you activate try to activate more speakers than the MP-40 can process.

---

*In the web interface the designation of the output can be grey text instead of white to indicate that these outputs are matrix generated.*

---

Activating top or height speakers requires that the lower level features side surrounds for optimal integration (LS, HS speakers). If you only have side or rear surround speakers, and these are mounted in the ceiling, they must be designated as lower level speakers, as you are not creating a 3-dimensional sound field.

If you set the Center speaker to “None”, the MP-40 will automatically route the dialogue from the center channel into the Left and Right speakers.



## RoomPerfect™

RoomPerfect™ is designed to analyze and correct for the negative effects that the listening room has on the speaker sound. See our website [www.lyngdorf.com](http://www.lyngdorf.com) for more detailed information.

### *Global filter*

The global filter improves sound quality across the whole room. When you are moving around a room, the global filter gives the best result.

### *Focus position*

The focus filter improves the sound quality at a specific listening position. This makes the focus filter the best solution for optimal sound quality at a single listening position.

---

*It is possible to add multiple focus positions. This must be done after RoomPerfect™ has been set up completely.*

---

### *Initial setup*

Be sure to select the unit of measure, then enter the distances to the speakers and subwoofers.

### *How to measure distances to speakers and subwoofers*

The best results are obtained by using a laser-equipped measuring device. Before starting, place the RoomPerfect™ microphone at listening height in the main listening position. For each channel, measure the straight-line distance through the air from the tip of the RoomPerfect™ microphone to the center of the tweeter unit in the loudspeaker in question. Do not measure distances at floor level, as these measurements will not give acoustically accurate results.

When measuring distances to **in-room** subwoofers:

- If the subwoofer(s) is in the corner of the room, measure the distance to the corner of the room.
- If the subwoofer(s) is up against the wall, measure the distance from the listening position to the back edge of the subwoofer.
- If you have a stack of subwoofers taller than the listening position, measure the distance from the listening position to the back edge of the middle of the stack.

When measuring distances to **in-wall** subwoofers:

- If the stack of subwoofers is taller than the listening position, measure the distance from the listening position to the dust cap of the middle of the stack of subwoofers.

- If the subwoofers are lower than the listening position, measure the distance from the listening position to the top dust cap of the top subwoofer.

### **Adjust subwoofer**

With an active subwoofer or more connected to the MP-40, this menu will guide you into setting the volume level on the subwoofer(s) controls. Follow the instructions on the display to go through two phases:

1. Find the correct system volume to do the Subwoofer adjustment (tones through speakers).
2. Find the optimal volume setting on the Subwoofer for the RoomPerfect™ calibration.

You can choose to use a volume setting other than the one requested by the system. The calibration will not be inferior in quality, but the time required for an exact measurement will be longer. If the volume setting is too high, the system will display “Error – Clipping”. Reduce the volume and try again.

### **How to set up RoomPerfect™**

---

*The RoomPerfect™ microphone is a very sensitive and finely calibrated device which must be treated with utmost care. If the microphone has been dropped on the floor, it may be damaged. If this is the case, obtain a new microphone from your Lyngdorf Audio representative before performing the system calibration.*

---

### **RoomPerfect™ preparations**

- Place the RoomPerfect™ calibration microphone on the stand. Be sure to fasten the screws properly so the microphone does not move during a measurement.
- Plug the supplied microphone cable into the microphone.
- Connect the microphone cable to the microphone terminal on the rear panel of your processor.

---

*Each RoomPerfect™ microphone is calibrated within very small parameters and using a new microphone does not require adding any calibration file. The microphone does not work with traditional power supply, and it cannot be replaced by any other microphone design.*

---

### Placing the microphone in the focus position

When you are prompted to place the microphone in the focus position, place the microphone, using the microphone stand, in your primary listening position. The height and the orientation of the microphone should correspond to your head's height and direction.

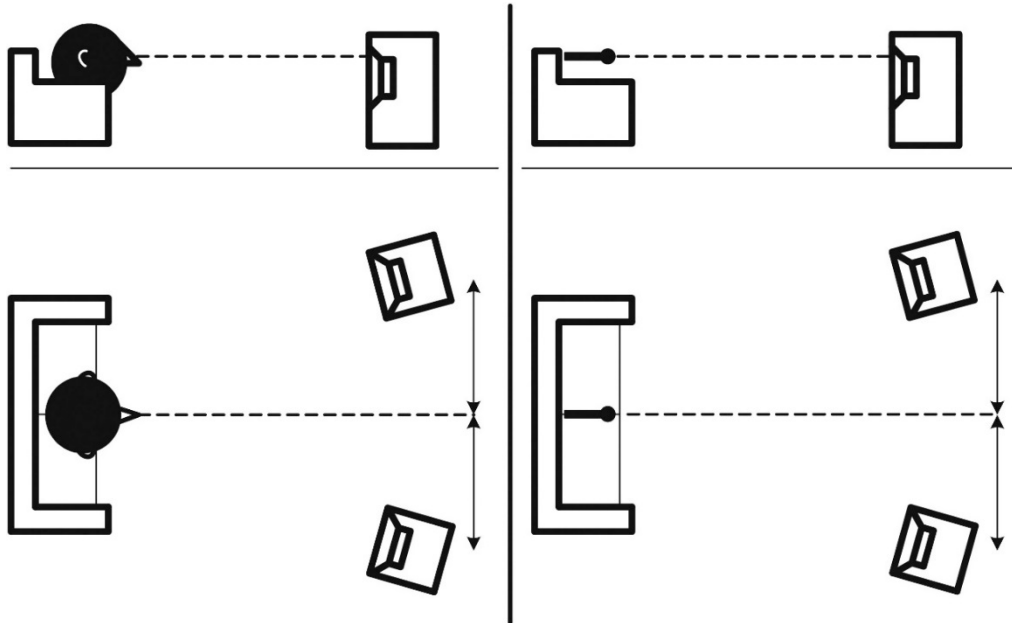

### Volume setting

Press Enter and a test signal will start from the left speaker. The system will give an estimated optimal volume for calibrating the system or will accept the current volume. Adjust the volume if required by the system and retry the measurement.

The calibration volume should not be so loud that it is inconvenient to you, or that it causes damage to your loudspeakers. If this is the case, set it to a lower and more appropriate level. A low volume can result in a longer calibration time or a measurement time-out. A low volume and long measurement will not affect the quality of the result.

### Measuring the focus position

When the calibration volume has been set, RoomPerfect™ will send a range of tones to measure the focus position. If there is noise in the room, the measurement may take longer. This will not affect the quality of the result. See RoomPerfect™ troubleshooting if the measurement stops prematurely, and then retry the measurement.

## Measuring random room positions

When the focus position has been measured, the next step is to measure the acoustical properties of the room. It is important to perform well spaced measurements to get a comprehensive image of the acoustical properties of the room. See RoomPerfect™ troubleshooting if the measurement stops prematurely.

Keep taking measurements until RoomKnowledge reaches minimum 90%.

These are the rules of thumb when measuring the room:

- The microphone should be in random and varying positions, heights, and orientations. Point it up/down/sideways, the more random positions the better.
- The measurements should cover the entire room, not only your listening area.
- Do not take measurements behind plants, furniture, etc.

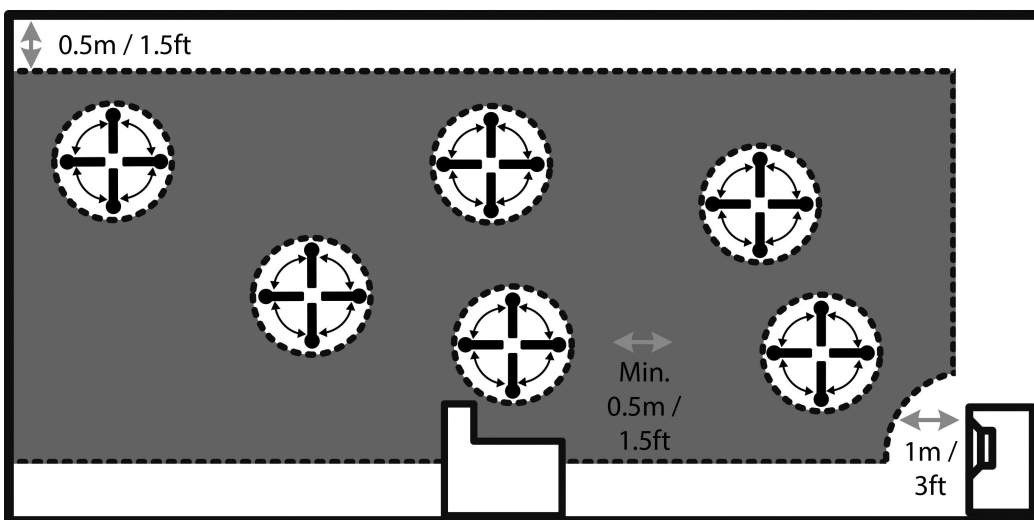

Side view of room

- The microphone should not be closer than 0.5m/1.5ft from the floor, ceiling, and walls.
- The microphone should be at least 1m/3ft from the front of the loudspeakers.
- There should be at least 50 cm/1.5ft between each measurement.
- Do not take symmetrical measurements in the room.

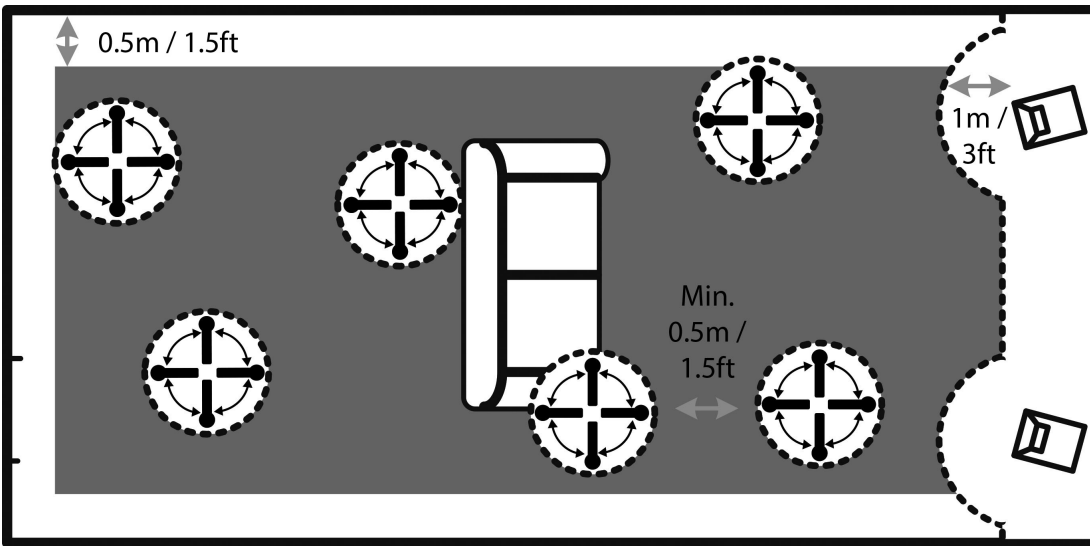

Top view of room

### Room measurements above 90% RoomKnowledge

When RoomKnowledge has reached 90%, you can decide to add room measurements or do it later.

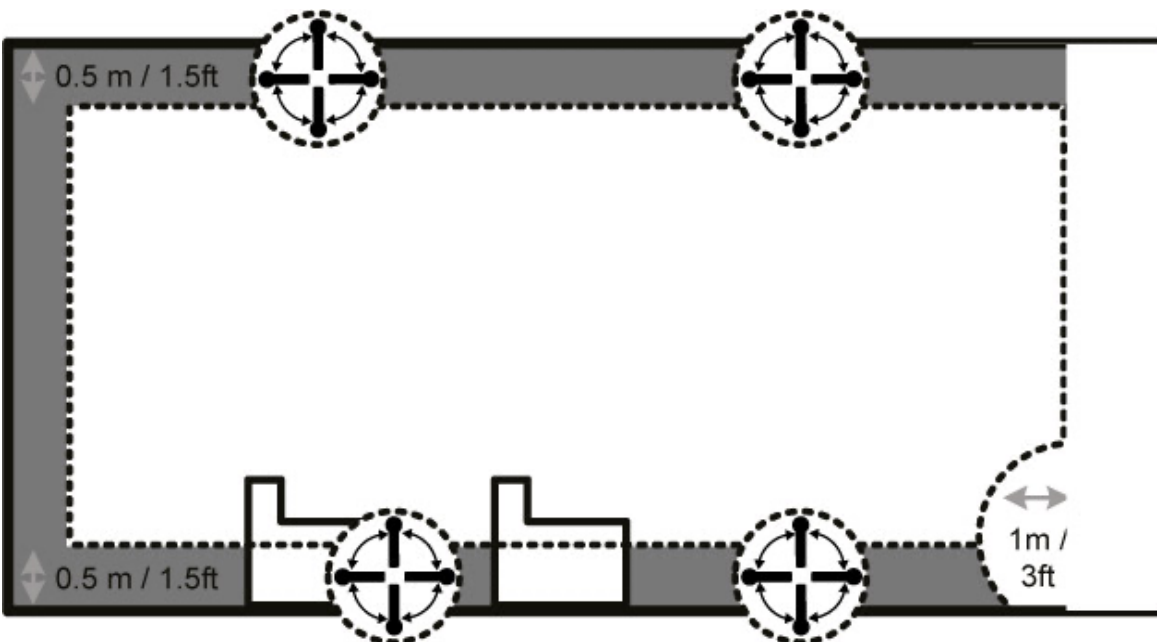

To fully optimize RoomPerfect™'s understanding of the room's acoustical properties, we recommend you keep doing measurements until the RoomKnowledge is above 95%. The higher the RoomKnowledge, the more accurate the room correction filters will be.

---

*Hot Tip: if the bass level is too high, you can add a few measurements within 50 cm/1.5ft of the walls and ceiling. In this area there is relatively high bass level, and the added measurements will result in the system bringing the overall level down.*

---

### **Calculation of focus and global filters**

When room measurements are complete, the system will calculate the focus and global filters automatically.

---

*Note: We recommend that you ALWAYS make a backup of the MP-40 settings and calibration data after having performed a RoomPerfect™ calibration (see Manage Software in the Setup section).*

---

## Audio Setup

### Audio Processing

This menu allows you to manage the audio processing presets for DTS, AURO and Dolby.

**Dynamic Range Control** functions in general with raising the level of quiet sounds and lowering the level of the loud sounds. This is also known as Night Mode, but it works differently in the various formats. This the reason why you can set it up separately for each format.

**Dolby Center Spread** is a dedicated Dolby function to spread the center channel dialogue into the left and right speakers to fit a very large screen.

**Auro Strength** sets the amount of generated signal in the postprocessing / up-mixing.

**Auro Presets** lets you select a channel configuration that best suits your speaker setup.

### Voicing Setup

A Voicing is an equalizer filter that can be activated to amplify or attenuate certain frequencies according to your personal sound preferences. For each Source you can dedicate a Voicing, meaning that you can emphasize bass on one input without sacrificing neutrality on others.

### Exporting and Importing Voicings

It is now possible to download single voicings to a file and to add new voicings by uploading those files as well. This will make it possible to copy a voicing from one device to another. The file format is identical for all enabled Lyngdorf products, so if you have a voicing you like on your TDAI-3400 amplifier, it is possible to add that to your Lyngdorf multichannel processor, or vice versa.

---

*Note: Single voicing files have the extension: single\_voicing.xml and this may not be changed.*

---

You can also download and upload an entire set of voicings. Again, these files will work throughout the devices which support this feature.

---

*Note: Uploading a set of voicings with this feature will replace ALL voicings in the amplifier. Files with an entire set of voicings have the extension: voicings.xml and this may not be changed.*

---

## Edit or delete voicing

This dropdown list contains the voicings currently in the amplifier. Selecting a voicing in the list will allow you to delete or edit the selected voicing (this will open the voicing editor)

## Add new voicing

To create a new voicing using the voicing editor, enter the name of your new voicing and press add.

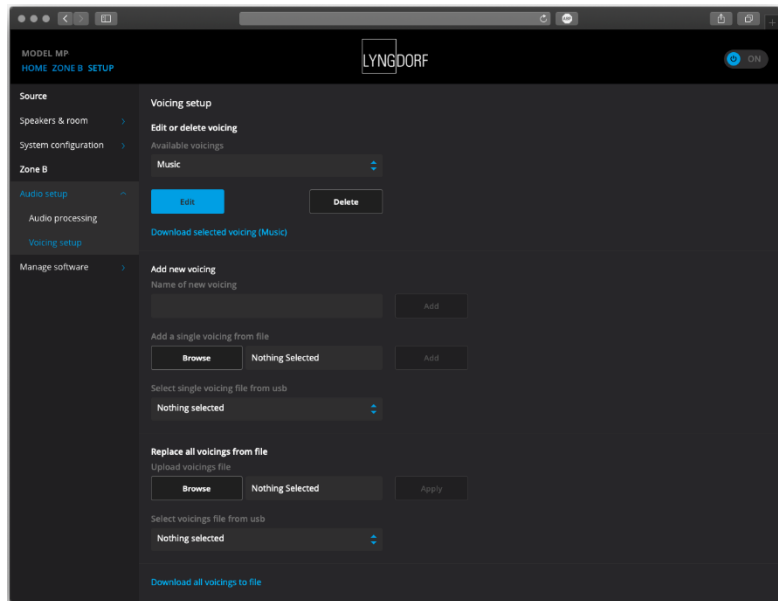

To add a voicing from a `.single_voicing.xml` file, browse for the file and then press add.

## Replace all voicings from file

This is the functionality to replace all voicings in the amplifier with a new set from a `.voicings.xml` file.

Remember that this will overwrite all voicings currently in the amplifier. Click browse to find the `.voicings.xml` file you wish to upload and then press Apply to use it.

On the bottom of the page is a link to download the current set of voicings in the amplifier to a `.voicings.xml` file.

Through selecting any of the stored Voicings, you can see the details by selecting EDIT. You can also delete the stored Voicings and add new designs here.

## Creating voicings

A Voicing can combine up to eight filter sections. For each section, you can choose between certain filter designs, which then in combination will give you the total correction of the Voicing.

For each Voicing you will see a green line showing the total correction as well a blue line showing the correction caused by the selected filter section. If there is only one active filter section, only the blue line is shown.

You can select between the following filter designs:



- Low Pass: Functions as a crossover filter reducing the signal above the frequency.
- High Pass: Functions as a crossover filter reducing the signal below the frequency.
- Low Shelf: Attenuates the lower frequencies to a specified level.
- High Shelf: Attenuates the higher frequencies to a specified level.
- Parametric: Attenuates specific frequency.

All these filters can be with positive or negative gain – effectively reversing the effect of the filter.

You can adjust the Overall gain for each voicing in order to be able to switch between voicings without experience any change in perceived level.

In this example (Action Movie Voicing) you will see the combined effect of two filter sections:

- Negative High Shelf from 120 Hz – creating a boost in the bass region.
- Negative High Shelf from 8,000 Hz reducing the highest frequencies.
- Overall gain set to +6 dB as compensation for the reduction in overall level experienced with the two filters.



Try experimenting by creating your own Voicings and test the functionality of the different filter sections

## Zone B setup

Zone B refers to an adjacent space, which is linked to the main setup. An example could be a bar area outside the listening area, where you want to play the stereo soundtrack of cinema or select any of the other sources connected to the MP-40. In this menu you can adjust the default settings.

The Zone B audio output can be controlled by a control system, the web interface or the remote application – not the handheld remote. This output can output a digital, stereo audio signal, which you can use as input for a system in adjacent rooms. The MP-40 can decode one HDMI source only and selecting “Follow Main” will output a stereo downmix of the movie in the main room. The output does not hold any RoomPerfect™ filters.

## System configuration

### General setup

#### *Power management*

- Choose the standby mode:
- Deep sleep: The MP-40 can only be turned on via the front on/off switch (Default)
- Network Stand-By: The MP-40 can also be turned on via web interface, Remote App or a control system.
- Choose the delay before auto off (minutes). Setting it to 0 will disable the feature.

#### *Default volume settings*

- Set a max volume for the device (dB). This setting is a safety precaution.
- Set startup volume.
- Use last volume: Sets the volume to be the same as when the MP-40 was turned off.
- Use fixed volume: Sets the default volume at startup.

#### *HDMI CEC settings*

Set "Enable CEC" and "Use ARC channel as audio input" to Off or On.

#### *Display timeout*

Set the time (in seconds) before turning off the display.

#### *Password protection*

Set a required password to enter the web setup section.

#### *Show bypass*

Set the RoomPerfect™ bypass mode for your device to Off or On.

#### *Enable front IR sensor*

Turn the MP-40's IR sensor Off or On. This function is useful if you are using a home automation system and other remotes are using the same IR codes as the MP-40 remote.

### *OSD info level*

Choose the level of information to show on the OSD.

## **Trigger In setup**

Allows you to set up the system so that it can be switched on via an external device in the system.

## **Trigger Out setup**

Allows you to set up the system so that the MP-40 can control other devices in the system.

- **Off:** No action.
- **Source:** When the preset source for any zone is selected, it will trigger. Use source setup menu to associate the trigger with a source.
- **Source A:** When the preset source for Zone A/Main zone is selected, it will trigger.
- **Source B:** When the preset source for Zone B is selected, it will trigger.
- **Power A:** When Zone A/Main Zone is On, it will trigger.
- **Power B:** When Zone B is On, it will trigger.
- **Power any:** When any Zone is On, it will trigger.

## **Network configuration**

Change the network mode to manual or automatic.

For more info, see the Network Setup chapter.

## **Streaming setup**

The MP-40 can access music files on your local network or on a storage device connected to the USB inputs, and you can stream music to the MP-40 from your mobile devices.

In this menu you can configure the basic setup of the music streaming:

- Streaming players can control volume. Set to Off or On.
- Streaming players can change input source. Set to Off or On.
- Streaming players can power on the device from standby mode. Set to Off or On.

## **Streaming playback**

The setup of the streaming player itself is done in the interface positioned in the HOME section.

## **UPnP**

This function allows you to select and play music files in UPnP enabled libraries on your local network. The button “..” brings you up in the menu structure of your library.

You might have problems in accessing files as UPnP a set of protocols and not a defined standard. The implementation of UPnP is therefore not always fully functional for media playback.

## **USB**

This function allows you to select and play music files on attached USB devices.

The button “..” brings you up in the menu structure of your library. It opens when an USB device is detected in any of the inputs.

## **vTuner**

This function allows you to access radio stations and podcasts around the world. You can search stations and podcasts through references to genre or geographical relation.

When a station or podcast is playing, you can assign it to one of the 4 “select save-position”. The saved stations can as presets be assigned to a SOURCE for direct selection, if you select “Internal Player” as “Audio input” (see menu: SETUP/SOURCE).

## **AirPlay**

When the MP-40 is connected to your local network, it will automatically be available from your AirPlay-enabled devices.

## **Spotify Connect**

When the MP-40 is connected to your local network, it will automatically be available from your Spotify Connect enabled devices (requires a Spotify Premium account).

## **Manage Software**

From this main menu, you can access MP-40 software information, backup, restore, etc.

## **Software Information**

Show reference information about the current software in the MP-40.

## Network Information

Show reference information about the network status of the MP-40.

## Backup

Make a complete system backup, including speaker setup and RoomPerfect™ measurements. When the backup is complete, the MP-40 will go into standby mode.

## Restore

Restore the system from a backup.

## Factory Reset

Restore the system to the default factory settings.

---

*Note: All user preference settings, system data, and RoomPerfect™ data are lost when the MP-40 is restored to the default settings.*

---

## Software Update

### *Update from remote files*

When connected to the Internet, the MP-40 can automatically download and update the software.

### *Update from local files*

#### *Via web interface:*

1. Click "Browse" to find a file stored on your computer.
2. Press "Upload" to upload it to the MP-40.
3. Click "Process" to initialize the update.

#### *Or:*

1. Upload the update to a FAT 32 formatted USB pen drive.
2. Make sure you "eject" the pen drive correctly before removing it from your PC/Mac.

3. Insert the pen drive into the MP-40.
4. Select the file in the menu and click "Process".

#### *Update Via OSD Interface*

1. Upload the update to a FAT 32 formatted pen drive.
2. Insert the pen drive into the MP-40.
3. Select the file in the menu and press OK on the remote control.

---

*Note: System settings and RoomPerfect™ data remain intact during software updates.*

---

## Troubleshooting

### **RoomPerfect™**

The calibration microphone is very sensitive and may pick up unwanted noise, including subsonic signals and background noise, which disturbs the measurements. If the signal is disturbed, it will take longer for the system to make a correct measurement.

A measurement that has been disturbed by noise but completed will always be correct; it is not necessary to redo it. If the measurement has stopped due to an error, one of the error messages below will be shown.

### **Error Messages**

#### *No microphone connected*

No microphone or cable is registered, why the microphone connection is not working. Check that the microphone cable is connected to the microphone socket on the back panel. If the problem continues, test the microphone cable by connecting the microphone directly into the microphone socket and select Retry.

If the microphone is detected, replace the microphone cable and retry the measurement.

#### *Fault – No signal*

This error message can arise due to a signal classification of no sound. This happens if the sound volume has been muted or a cable is disconnected.

- Check the sound volume.
- Check all cable connections, including interconnects, speakers, amplifiers, etc.

- Check the measuring signal volume.

If none of these measures solve the error, request a replacement microphone from Lyngdorf Audio.

#### *Fault – Signal clipping*

Either the incoming signal has been classified as too loud, resulting in clipping or distortion, or a loud noise in the immediate environment has corrupted the measurement results. If a loud noise has in fact occurred, such as the sound of a closing door, reduce noise levels inside and in the immediate vicinity of the room and repeat the measurement. If no loud noise has occurred, reduce the volume of the signal and repeat the measurement.

#### *Fault – Low signal*

This error message is displayed when the measurement has lasted more than 5 minutes for the low-frequency signal or more than 2 minutes for the high-frequency signal. This happens most often when using a low-level measuring signal compared to the background noise in the listening environment, which results in prolonged measuring times. Raise the measuring signal volume or reduce the noise in the environment before continuing with the measurement.

If raising the volume does not eliminate the error message, the microphone or cable might be defective. Test the microphone cable by connecting the microphone directly into the microphone socket and select Retry.

#### *Can't Turn On Via LAN or Control System*

The MP-40 needs to be set to Network mode to be able to turn on via a control system. It will not turn on when in Deep Sleep. This is set up in Device Management -> Power.

#### *Retrieving and Sending an Error Log*

The processor generates a log file, which contains information of all detections and actions made by the software. To retrieve an error log holding, you need to access the MP-40 via your browser. Under "Manage Software" you can download a text file and email it to your Lyngdorf Audio representative.

#### *3D Compatibility Not Detected*

If the MP-40 isn't fully booted, a Blu-ray player will not be able to detect its 3D compatibility. Restart the player to fix the problem.

### Remote Control Doesn't Work

The remote control is paired to the MP-40 at the factory; you need to pair it again only if you have a new MP-40 or remote. To pair the RF remote control to a MP-40:

1. Turn on the MP-40.
  2. On the remote hold down Play and OK until the remote control's green LED flashes.
  3. Point the remote control at the MP-40 and hold it within 30 cm / 1 foot of the front panel. When the green LED stops blinking, the remote is connected via Zigbee.
  4. The remote will be paired to the MP-40.
- To switch the remote from RF to IR mode, hold down OK and 1. The LED will flash red twice.
  - To switch the remote back to RF mode, hold down OK and 2. The LED will flash green twice.
  - To reset the pairing of the remote control, press Back and OK until the red LED flashes twice.

## Network Setup

### Connecting to MP-40 with a network cable

It is possible to get access to the MP-40's web interface via a direct cable connection between the MP-40 and a computer, or a connection via a hub or switch.

If you have a direct cable connection to a laptop (with no switch or router between the two) the network cable must be a crossover type. Furthermore, the Mode option in the Network Setup menu must be set to Manual IP. Finally, you must manually set an IP address on the computer you intend to use for setting up the MP-40.

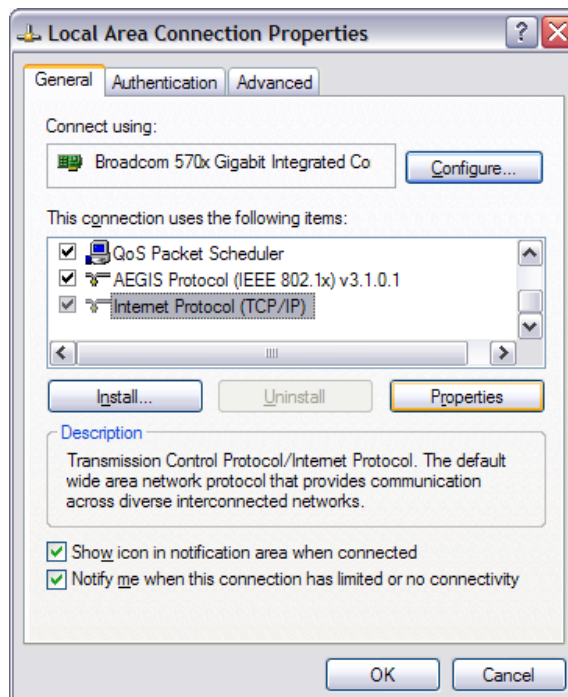



## Set Up a Fixed IP Address in Windows 7

- Click Start / Control Panel / Network Connections to find the network connection that represents your connection to the Internet. Most often, this is labeled simply Local Area Connection.
- Right-click the connection and select “Properties”.
- Click “Internet Protocol (TCP/IP)” in the list (you may have to scroll down the list to find it).
- Click “Properties”.
- Most default configurations will have both “Obtain an IP address” and “Obtain DNS server address” automatically selected by default.
- Click “Use the following IP address” and enter the following:
 

IP address:	192.168.1.2
Subnet mask:	255.255.255.0
Default gateway:	192.168.1.1
- Click “OK” to close the configuration windows. You should now be able to access the MP-40 via your Internet browser.

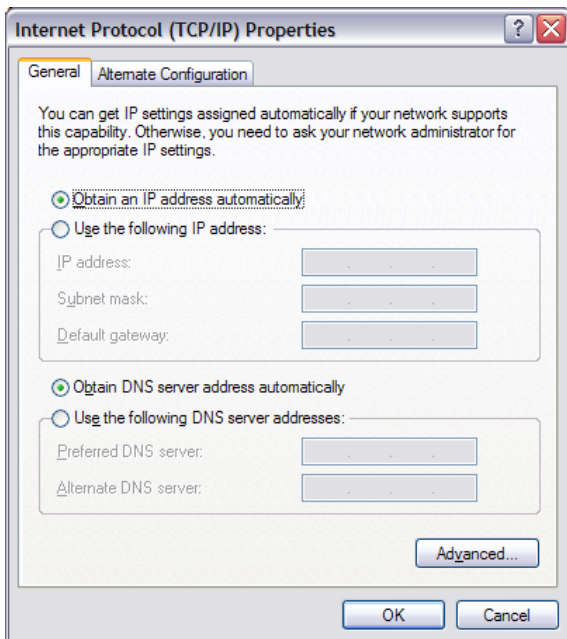

## Set Up a Fixed IP Address in Windows Vista or Windows 10

- In Windows Vista, click Start / Control Panel / Select Network and Internet / Network and Sharing Center.
- In Windows 10, right-click Start, then select “Control Panel”.
- Select “Network and Internet / Network and Sharing Center”.
- Click “Manage Network Connections” in the list of tasks.
- Right-click your local area connection and click “Properties”.
- Select “Internet Protocol (TCP/IP)” from the list.
- Click the “Properties” button.

- Click “Use the Following IP address” and enter the following:  
IP address: 192.168.1.2  
Subnet mask: 255.255.255.0  
Default gateway: 192.168.1.1
- Click “OK” to close the configuration windows, and you should now be able to access the MP-40 via your Internet browser.

## Trademarks

For DTS patents, see <http://patents.dts.com>. Manufactured under license from DTS Licensing Limited. DTS, the  Symbol, & DTS and the Symbol together are registered trademarks, and DTS:X and the DTSX logo are trademarks of DTS, Inc. © DTS, Inc. All Rights Reserved.

HDMI, the HDMI Logo and High-Definition Multimedia Interface are trademarks or registered trademarks of HDMI Licensing LLC.

Dolby and the double-D symbol are registered trademarks of Dolby Laboratories.

This product incorporates technology that is protected by U.S. patents and other intellectual property rights. Use of this technology must be authorized by Macrovision, and is intended for home and other limited viewing uses only, unless otherwise authorized by Macrovision. Reverse engineering or disassembly is prohibited.

This item incorporates copy protection technology that is protected by U.S. patents and other intellectual property rights of Rovi Corporation. Reverse engineering and disassembly are prohibited.

HDBaseT™ and the HDBaseT Alliance logo are trademarks of the HDBaseT Alliance.

## Service information

In order to obtain warranty service, you must contact your original dealer or the Lyngdorf Audio distributor of the region or country where you are located.

